



1032 N. Irving St.
Allentown, Pa. 18109 USA
Phone# 610 434-6004 Fax# 610 434-6607
Web Site www.vastex.com
E-Mail info@vastex.com

INSTRUCTION MANUAL FOR

Vastex Exposit



Model# E2227



Model E2227-L

Required documentation:

On the outside of the box:

1. **01-04-001 Quick Set-Up Guide**

On the inside of the box:

1. **Vacuum Pump Data Sheet.**
2. **ATC Timer Data Sheet**
3. **Instruction manual binder containing the following documents:**

- 01-04-001 (Quick Set-Up Guide)
- 01-04-002-A (Operating Instructions)
- 01-04-008 (Leg and Bulb Installation)
- 02-04-003-B (Wiring Diagram 120 V)
- 02-04-008-B (Wiring Diagram 240V)
- 01-00-005 (Warranty)
- 01-00-006 (Warranty Summary)
- 01-00-015 (Terms and Conditions)
- 01-04-007 (Tips for Emulsion by Douglas Grigar)
- 01-04-015 (Blanket Replacement Instructions)

Quick Set-up Guide for Your EXPOSIT

The EXPOSIT has been tested and inspected prior to shipping.

Any damages found, will have occurred during shipping and must be reported directly to the freight company.

1. **Unpack:** Remove straps, plastic shrink wrap and wood frame. (Be careful not to damage the rubber blanket)
2. **Set aside any loose components:** Optional legs or registration system.
3. Remove the lag bolts holding the feet to the skid, a 1/2" wrench will be needed.
4. **For units with optional legs:** Please refer to doc# 01-04-008 for leg assembly.
5. **For table top units** Lift unit onto your table for ease of assembly.
6. **Level your Exposit:** The unit **must be leveled** to prevent glass breakage. The best place to check the level is on top of the cabinet during bulb installation. (See step 7)
7. **Install lights:** (4) Black center bulbs(E2227) or (10) Black center bulbs (E4427) and (2) white outside. (See doc# 01-04-008 for instructions to safely open bottom lid where lights are stored during shipping.)
8. **Install the loose end of each gas spring** (See doc# 01-04-008).
9. **All switches must be in the "off" position:** Plug your machine into a grounded outlet.
10. **Check all bulbs.** Turn on and off the white set-up lights (outer two). Then check the expose lights. The white lights will come on with the expose switch. The black lights will appear to be dim. Do not look at the black light for more then a few seconds. The UV light can be harmful to your eyes.

Note: If a spare rubber blanket was ordered it must be stored properly. Do not allow the blanket to be folded or creased and store away from heat and chemicals.

You're ready for a dry run.

1. Set the timer to (1) minute. (Actual Exposure time will vary greatly with emulsion types and application variations.)
2. Put an uncoated screen on the glass against the stops with the fabric down, and lock the two handles down.
3. Turn the vacuum pump on. The vacuum will flatten the blanket up to an inch or two from the frame.
4. Turn the timer switch on after the blanket is flat. You will see a light on the timer flashing. It will flash more frequently as the time gets closer to completion. See the ATC timer manual for more specific timer specs.
5. When the light starts flashing rapidly, like a strobe, the (1) minute is up. The exposure lights and vacuum will shut off automatically.
6. Turn the vacuum and timer switch to the "off" position.
7. Release the two lid locks and lift the upper lid to remove the screen.

The above instructions are for a quick set up overview only. It is imperative that you read your owner's manual for a complete understanding of the operating instructions, troubleshooting, and maintenance of your Exposit system.

VASTEX EXPOSIT Operating Instructions DOC# 01-04-002B

I. Installation

- A. Please follow the Quick Set-up Guide doc#04-01-001 found on the outside of the box and with this manual. **Be sure to level the cabinet to prevent glass breakage.**

II. Installation of (OPTIONAL)VRS: Follow this section if using the optional Pin Registration System. You can skip this section and come back at a later date if you want to get to exposing screens right away.

- A. **Install registration pins into tabs.** Two 1/4" round pins and tabs to match, and two 5/16" flatted round pins with a slotted tabs to match are supplied. The pin heads go on the adhesive side.
- B. **Install tabs and pins onto pin board** using the punched sheets as a template. Install one set of tabs onto one punched Mylar sheet. The pins will be located at the very top edge of the pin board. Center the sheet left to right and all the way to the bottom of the pin board.
- C. **Install pins onto Exposit glass** using the pre-punched Mylar as a jig. Locate the center of your lit area and mark it with masking tape or something easily removable. Mark the center of the image area on the Mylar jig you are using. Line the two up on the glass,(the pins will be mounted closest to the operator) and adhere the pins down. Be sure the 1/4 round is the same as what you chose on the pin board. Both to the left or right. *See drawing# 1196*

III. Electrical connection All exposing units are a totally pre-wired, pre-tested unit.

- A. 120 volt units: A grounded 15 amp 120 volt AC plug and cord Nema 5-15P is provided.
- B. 240 volt units: A grounded 15 amp 240 volt AC plug and cord Nema 6-15P is provided.

IV. Screen emulsion application. Also see attached "Emulsion information for the screen printer"

- A. *After degreasing and drying your screens*, fully coat the outside surface of the screen with a scraper/applicator which is somewhat smaller in length than the inside dimension of the screen frame. A scraper/applicator that is flat, flexible, and easy to palm in one hand usually gives the best results. The room must be dimmed, a yellow light can be used.
1. First application - use one stroke to completely seal the mesh. Allow 30 minutes to dry with warm flowing air in exhausted dark drying cabinet. It may not be necessary to seal edges now.
 2. Note: a smaller hand scraper should be used for fully coating the outside edges.
 3. Second application - several full passes inside and outside of the screen, sealing around the edges may be convenient now.
- B. Let dry overnight in the cabinet with no light. Go to www.vastex.com's "How to Print" section for tips on drying cabinets.

Caution! Screens must be free of sharp edges. All surfaces coming in contact with blanket should be rounded and smooth. **Any edges not rounded should be covered with a thick tape, piece of rubber or cloth.** Keep several pieces of cloth or thin rubber close to the Exposit to cover sharp edges prior to closing lid.

V. Operation

- A. **Vacuum pump:** *The object is to flatten the blanket in the image area. Removing the air creates a vacuum and holds the positive and coated screen tight to the glass. This will help in making a sharper image.*
1. Raise the lid and place the positive and screen against the three screen stops. Carefully lower and lock the lid.
 2. Turn on vacuum pump and allow 20 to 45 seconds for the pump to remove the air from between blanket and glass.

B. Note: upon installation, the top lid with its rubber seal might have to be adjusted for proper sealing. If the vacuum cannot flatten the blanket to within an inch from the frame on startup, a problem may exist within top seal. Both the rear hinges and the front clamp are adjustable if the seal should require re-alignment.

C. **Exposing.** (Be sure your glass is clean on both sides.)

1.Exposing timer - an automatic timer is provided for timing the screen exposure.

a. Analog Timer (Standard) - The timer is set to display a 10 minute dial. To activate the timer, rotate knob to desired set point - **see chart below**, and push expose rocker switch to the on position. The timer will automatically turn the six lights on.

b. Digital Timer (Optional) - This timer has an LED display to allow precise time settings. To activate the timer, set it to the desired exposure time - **see chart below** - and push expose rocker switch to the on position. The timer will automatically turn the six lights on.

(Note: We have adjusted the digital timer to be in seconds, with 2 decimal places. If you wish to change these settings, please see your timer manual.)

Recommended Exposing Chart

Using a premixed pure (non diazo) emulsion.

Exposure times can vary greatly depending on the emulsion used.

Type of screen to be exposed	Time it should be exposed for
coated fine screens (1) coat/side	1 - 3 minutes
coated (1) coat ink side (2) coats garment side of screen	3 - 5 minutes
heavily coated mesh 2-3 coats/side	5 - 10 minutes

2. An led located on the timer face will flash once, then pause. It will then flash more rapidly as it gets closer to completion. Once it is timed down the exposure lights and pump will shutoff. The LED will flash rapidly until the operator shuts the rocker off. Upon shutoff of the switch the timer will automatically reset for next exposure.

3. After exposure timer has run down, turn vacuum pump switch to the off position.

(Note: the vacuum pump will turn on again after the expose switch is turned off if the vacuum is not turned off first. Make sure to turn the pump switch back off when done exposing.)

4. Turn the timer switch to the off position.

5. Rotate the air bleeder valve counterclockwise to break vacuum on blanket

6. Unlatch and lift top slowly. Care should be exercised when lifting the top after exposure of screen that the screen has not stuck to the blanket.

D. **After exposing**

1. Once the screen has been exposed, thoroughly wash screen, blot dry with a newspaper, and finish drying by blowing excess water off with an air hose or vacuum off with a wide flat nozzle. Be sure nozzle is free of sharp edges.

2. After washing and drying, the areas of the screen along the edges that were initially missed should now be coated with emulsion. This compound may be brushed on, ensuring a generous coating around the corners where the fabric and frame are in contact. With proper sealing, no tape should be necessary. Taping can be used if desired.

- VI **Standard white lights.** Located on ends of light tray.
This exposing unit incorporates two standard white fluorescent lamps which when turned on convert the exposing unit into a back lit table which may be used for art work and tracing. These lights will also illuminate during exposure.
- VII **Black UV Lights.** Note: UV light is not a visible light. They will have a low blue tint. The four bulbs (E2227) ten bulbs (E4427) in the center are black light p/n 04-08-006. They illuminate only when timer is activated. You should change as needed when longer exposure times are noticed. Changing the bulbs once every 1-2 years depending on frequency of use would be a safe practice.
- VIII **Maintenance and Adjustments:**
1. **Clean the upper and lower side of the glass.** See Doc# 01-04-006 for instructions on how to safely lift the lower lid. Keep glass clean; debris on the glass will cause pin holes in your exposed screen.
 2. **Check the bulbs for proper operation.** Replace defective bulbs promptly or if longer exposure times become frequent. New bulbs every two years will help keep your exposure times consistent.
 3. **If vacuum will not put blanket down:**
 - 3.1 Inspect blanket for tears or holes. Use a tire patch on the outside of the blanket to repair.
 - 3.2 Check the lid seal. A foam seal running around the perimeter of the lid pushes the blanket against the glass to form the seal. Check to be sure the seal is not defective or torn.
 - 3.3 The lid may just need to be adjusted down further. Determine which corner is the problem, then use the following diagrams to help adjust the lid.

The front two corners will use shims provided to adjust the lid seal. Adding one shim will lower that corner $\frac{3}{64}$ ". Use a $\frac{7}{16}$ " wrench and loosen the 4 bolts. Slide the shim under and re-tighten the bolts making sure the bracket is tight against the lid.

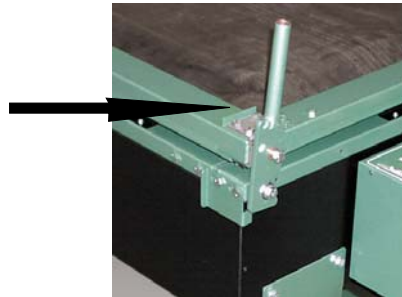

The rear two corners will use the rod end coupling for adjustment. Use the two nuts to lower or raise the upper lid. A $\frac{1}{2}$ " open end wrench is needed. Loosen the upper nut one full turn then tighten the bottom nut. This will lower the corner $\frac{3}{32}$ ".



Photo illustrations for leg assembly.



Bolting flange.



LID LATCH. Shown in locked position



KICK STAND Shown in up & locked position.



GAS SPRING. Shown inserted.

Leg and Bulb Installation Instructions.

1. Stand both legs up on flat surface and space apart to line up with holes on Exposit feet.
2. With one person on each side lift exposing unit up and place onto the legs.
3. Align holes and insert the ½-13 bolt with a washer under the head. (4) total.
4. Then install washer and nut and tighten. A ¾" wrench will be needed.

Follow the next steps for procedures to open both lids together, for access into the exposure cabinet. The lower lid with the glass attached is heavy, be careful and closely follow the steps listed.

5. With the upper lid down and locked, slide the two LID LATCHES to the locked position and tighten the knobs. This will keep the upper lid locked to the lower lid.
6. Lift both lids together (be careful they are heavy) and lock (1) kick stand E2227 or (2) kick stands for E4427, in place. (The kick stands are located on the left and right side See photo)
7. While the lids are up the lights can be installed.
The white bulbs are installed on the two outside positions.
8. Slightly lift the two lids and unhook the kick stand.
9. Lower the lids back to the down position (BE CAREFUL THE LIDS ARE HEAVY)
10. Slide the lid latches back to the unlocked position (towards the center).
11. Lift the upper lid and install the gas springs as shown in the photo.

Doc# 01-04-008

REVISIONS

REV	DESCRIPTION	DATE	BY	APP'D
B	ADDED PUMP RELAY 1CR & PARTS LEGEND	05/23/06	MVAS	MVAS

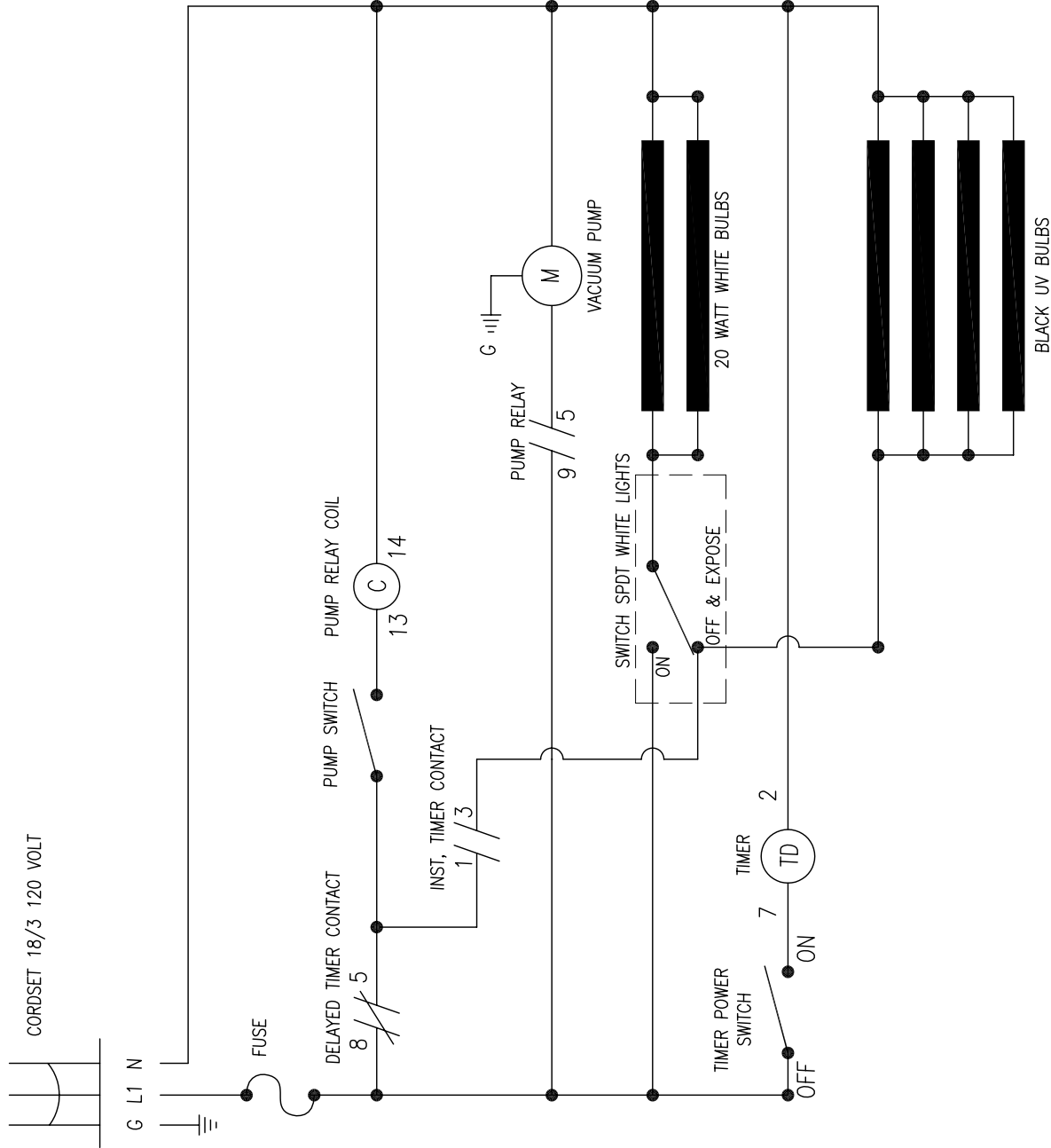

LEGEND

DISCRPTION	PART NO.
BULBS BLACK UV (20 WATT)	04-08-006
(OPTIONAL) BULBS BLACK UV (40 WATT)	04-08-040
BULBS WHITE	04-08-012
CORDSET 18/3 120V	04-03-013
FUSE 5A MDA	04-03-026
FUSE HOLDER	04-03-076
PUMP VACUUM	04-02-027
PUMP SWITCH	04-01-019
PUMP RELAY 5A "ICE CUBE"	04-01-070
PUMP RELAY SOCKET	04-01-071
SWITCH SPDT "WHITE LIGHTS"	04-01-020
(OPTIONAL) TIMER ANALOG (TD)	04-01-085
TIMER DIGITAL (TD)	04-01-083
TIMER BASE 8 PIN	04-08-004
TIMER POWER SWITCH	04-01-019
BALLAST	04-01-052

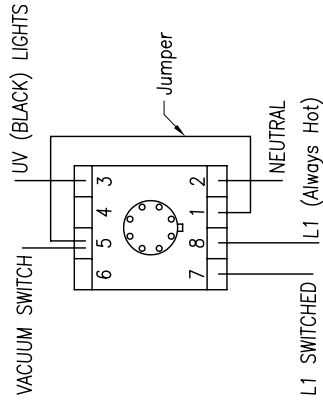

TIMER CYCLE

DELAYED TIMER CONTACT IS NORMALLY CLOSED, OPENS ONLY AT END OF TIMED CYCLE
 TIMER RESETS BACK TO CLOSED AFTER EXPOSE SWITCH IS OPENED, (TURNED OFF)

INST. TIMER CONTACT IS NORMALLY OPEN, CLOSSES WHEN EXPOSE SWITCH IS CLOSED (TURNED ON)

		TITLE: LADDER DIAGRAM EXPOSIT 2227 120 VOLT 60HZ ELECTRICAL DRAWINGS	
		BY DATE MVS 10/1/06	SCALE: NONE
DRAWN MVS	CHECKED MVS	SIZE C	DRAWING NO. 02-04-003
APPROVED	SCALE: NONE	SHEET 1 OF 1	REV# B

REVISIONS			
REV	DESCRIPTION	DATE	BY APP'D
A	updated drawing		
B	added EU Cordset, 04-03-152	12/14/07	CD

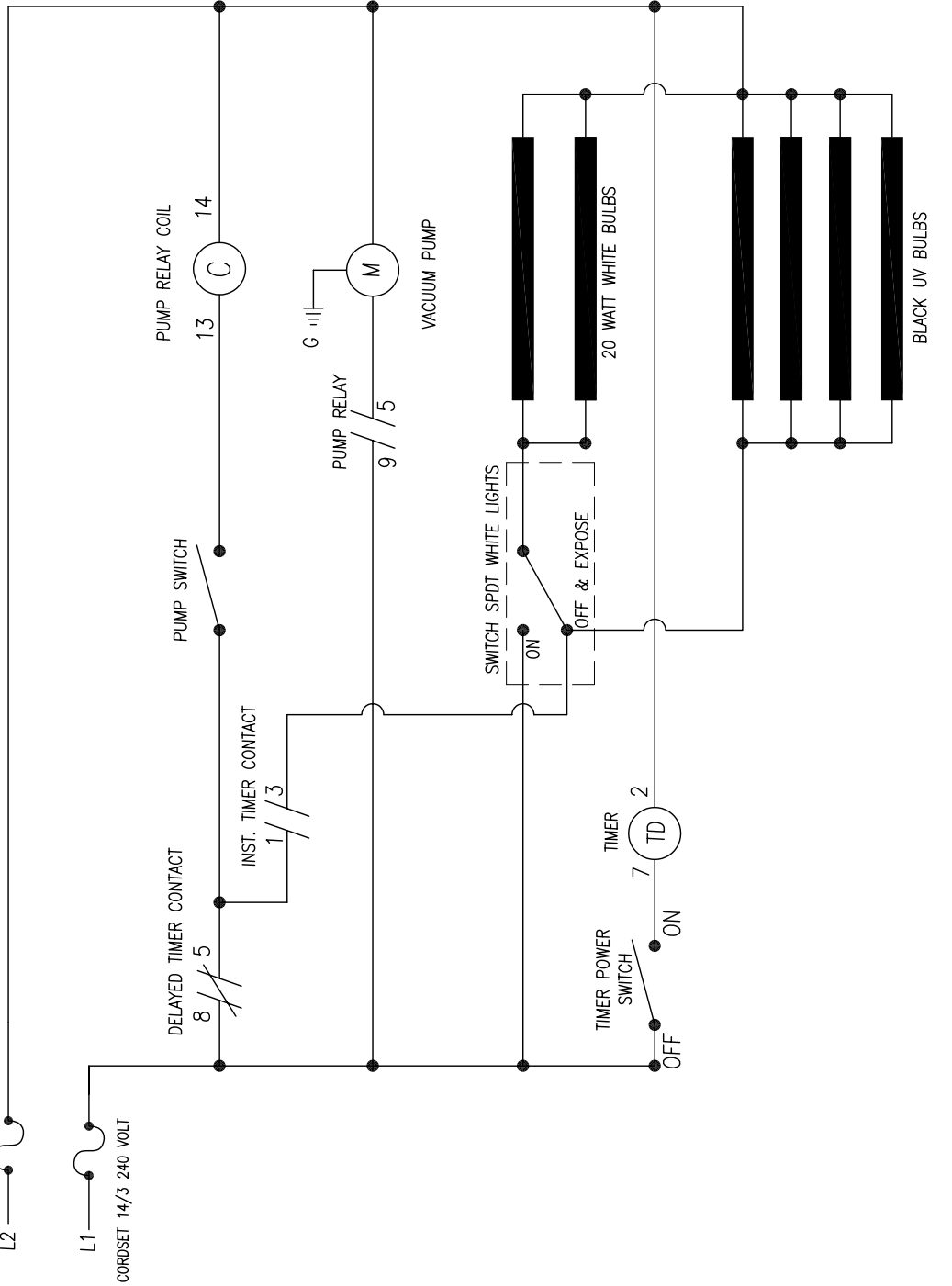

LEGEND

DISCRPTION	PART NO.
BULBS BLACK UV (20 WATT)	04-08-006
(OPTIONAL) BULBS BLACK UV (40 WATT)	04-08-040
BULBS WHITE	04-08-012
(for US Models) CORDSET 14/3 240V	04-03-011
(for EU Models) CORDSET 6 AMP	04-03-152
FUSE 5A MDA	04-03-026
FUSE HOLDER	04-03-076
PUMP VACUUM	04-02-029
PUMP SWITCH	04-01-019
PUMP RELAY 5A "ICE CUBE"	04-01-079
PUMP RELAY SOCKET	04-01-071
SWITCH SPDT "WHITE LIGHTS"	04-01-020
TIMER ANALOG (TD)	04-01-085
(OPTIONAL) TIMER DIGITAL (TD)	04-01-083
TIMER BASE 8 PIN	04-08-004
TIMER POWER SWITCH	04-01-019
BALLAST	04-01-052

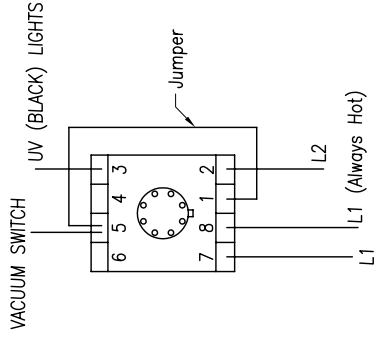

TIMER CYCLE

DELAYED TIMER CONTACT IS NORMALLY CLOSED, OPENS ONLY AT END OF TIMED CYCLE
 TIMER RESETS BACK TO CLOSED AFTER EXPOSE SWITCH IS OPENED, (TURNED OFF)
 INST. TIMER CONTACT IS NORMALLY OPEN, CLOSES WHEN EXPOSE SWITCH IS CLOSED (TURNED ON)

VASTEX ALLENTOWN PA. USA

TITLE: LADDER DIAGRAM
 EXPOSIT 2227 240V 50/60 HZ
 ELECTRICAL DRAWINGS

DRAWN	BY	DATE	REV#
MVAS			B
CHECKED			
APPROVED			

SIZE: DRAWING NO. 02-04-008
 SCALE: NONE
 SHEET 1 OF 1

Vastex Warranty

Doc#01-00-005 Revised 11/20/2002

Vastex, hereinafter referred to as "seller" warrants only to its original "purchaser", who holds a copy of the original invoice and is the original end user of the equipment in question, its new equipment against defects in workmanship on a pro-rated basis for a period of three (3) years from the date of shipment to buyer and receipt of payment in full. Infrared heaters installed by Vastex in a new dryer will be covered for a period of (10) years. Replacement parts are covered for a period of (1) year from ship date contingent on payment in full, with the exception of replacement infrared heaters, which have a (3) year warranty. All sales made through Vastex dealers must be certified by that dealer before a warranted replacement is issued.

This warranty is expressly contingent upon the buyer delivering to seller, at the address below, with all transportation charges prepaid, the part or parts claimed to be defective within the above mentioned period (3) years for new equipment, (10) years on the heaters and (1) year for replacement parts, with the exception of replacement infrared heaters, which have a (3) year warranty. If the machine in question is less than a year old, it will be shipped to the customer at no charge, with an RGA issued by Vastex for the defective part. The defective part must be shipped back to Vastex within 30 days or the account will be billed. If the equipment is more than a year old, the part will be shipped after we receive the defective part. If it's necessary to expedite the movement of parts and to minimize down time to the buyer, the replacement part shall be supplied on a C.O.D. basis. If testing and analysis of said part by the seller or its supplier discloses that said part is defective, the cost of said part will be refunded to the buyer on a pro-rated basis.

Except as otherwise provided herein, the equipment is being sold "as-is". Final determination of the suitability of the equipment for the use contemplated by the buyer, is the sole responsibility of buyer, and seller shall have no responsibility in connection with the suitability.

All warranties implied by law, including the implied warranties of merchantability and fitness are hereby limited to workmanship and defective parts to a period of (3) years for new equipment and 10 years for the heaters in said equipment and (3) years (for replacement infrared heaters) and (1) year (for replacement parts) after date of shipment to first buyer. The express warranty and remedies contained herein and such implied limited warranties are made solely to the sole warranties and remedies and are in lieu of all other warranties, guarantees, agreements, and other liabilities, whether express or implied, and all other remedies for breach of warranty or any other liability of seller, in no event shall seller be liable for consequential damages.

No person, agent, distributor, or service representative is authorized to change, modify or extend the terms hereof in any manner whatsoever.

These terms and conditions are an essential part of the transaction between the parties and constitute the entire agreement between them with respect to the same.

Some states do not allow limitation on how long an implied warranty lasts of the exclusion or limitation of incidental, or consequential damages, so the above limitation may not apply to you.

This warranty gives you specific legal rights, and you may also have other rights which vary from state to state.

Infrared heaters are the only replacement parts covered for a period of (3) years from date of shipment and contingent to receipt of payment in full.

Electrical components can not be returned once installed unless proven defective.

Please refer to doc. 01-01-006 for warranty implementation help.

Please refer to doc. 01-00-015 for specific terms and conditions of sale and the limited warranty.

Please refer to doc. 01-00-017 for V-2000HD printer warranty.

This revised warranty effective as of 11/20/2002

F:\Shared\Vastex\01-Manuals & Doc\00-misc\01-00-005 (Warranty).wpd

VASTEX
INTERNATIONAL

1032 N. IRVING ST.
ALLENTOWN PA. 18109 USA

VASTEX WARRANTY IMPLEMENTATION SHEET

Please read this document in order to fully understand the warranty.

Doc.# 01-00-006

Your new Vastex equipment is protected against *manufacturers' defects by our warranty, completely explained in doc# 01-00-017 for the V2000-HD series manual printer and in doc# 01-00-005 for all other Vastex manufactured equipment. Please refer to these documents for the **warranty term and specific concerns about the warranty. The following are some important facts and requirements for the proper implementation of the warranty.

1.0 Everything is covered!

2.0 **Warranty Term is defined as: Ship date from VASTEX to the date the item in question is returned to VASTEX for inspection and repair.

3.0 *Manufacturers defects are defined as: Parts determined to be defective in workmanship which will lead up to a premature failure. The determination will be made only by the manufacturer of the item in question.

4.0 To take advantage of the warranty the following steps must be taken:

4.1 The equipment must be paid for in full.

4.2 The item in question must be shipped to VASTEX for evaluation with all shipping costs incurred by the buyer.

4.3 If the item is deemed as a manufacturer's defect it will be repaired or replaced within 2 business days from the time received. The shipping cost back to the customer located in the continental United States will be paid by VASTEX if a warranty item.

4.4 **If the item in question must be replaced immediately and is more than a year old, it will have to be purchased at list price and will be shipped COD. A pro-rated credit will be given promptly if the returned item is a valid manufacturer's defect.**

4.5 If the equipment was shipped less than a year before the date of the service call and a technician confirms the part needed for repair, the replacement will be shipped before the replacement is shipped back. An RGA will be issued and must accompany the old part to VASTEX within 30 days or the account will be billed.

5.0 Important facts about the condition of shipped equipment:

5.1 Dryers are partially assembled with the belts tracked and the machine run at full temperature for a min. of 1 ½ hours.

5.2 Printers are partially assembled, inspected, and adjusted for all heads down prior to partial disassembly and packing.

5.3 Exposing units are fully assembled and tested with the maximum screen size for vacuum integrity, timer operation and light output.

6.0 This document is in addition to the standard warranty and only helps the customer understand how to take advantage of the warranty. In no way does this document override the standard warranty or the terms and conditions of sale and the limited warranty doc# 01-00-015.

Please see doc# 01-00-015 for specific terms and conditions of sale and the limited warranty

VASTEX
INTERNATIONAL

1032 N. IRVING ST.
ALLENTOWN PA. 18109 USA

Vastex International, Inc.

TERMS AND CONDITIONS OF SALE AND LIMITED WARRANTY Doc.#01-00-015

1. Buyer's order will constitute an offer in accordance with the terms hereof and such offer, upon acknowledgment of Seller, will constitute the agreement between Buyer and Seller. Buyer's order after such acknowledgment by Seller will not be subject to cancellation, change or reduction in amount, or suspension by Buyer of deliveries, unless prior to such action Buyer has obtained Seller's written consent. Notwithstanding anything to the contrary in Buyer's Purchase Order or other communications, the parties agree to be bound by these Terms and Conditions. Acceptance of the product by the Buyer shall be deemed to constitute unconditional acceptance of these Terms and Conditions.

2. Any of these terms, conditions and provisions of Buyer's order which are inconsistent with Seller's acknowledgment and these Terms and Conditions of Sale shall not be binding on the Seller and shall be considered not applicable to any sale so made. No waiver, alteration or modification of any of the provisions on either side of the document shall be binding upon Seller unless agreed to in writing by Seller.

3. (a) All prices are F.O.B. Seller's Plant and method of delivery and routing shall be at Seller's discretion, unless specifically otherwise stated herein. Notwithstanding any agreement to pay freight, delivery of products purchased hereunder to a common carrier or licensed trucker shall constitute delivery to Buyer and be determinative of the date and time of shipment and all risk of loss or damage in transit shall be borne by Buyer. If the Buyer fails to accept the goods from the common carrier or licensed trucker, the Seller shall be entitled to claim payment from the Buyer. Seller shall arrange for storage, the risk and the cost, including insurance costs, to be borne by the Buyer (and Buyer agrees to pay such amounts upon demand) except if the failure to accept delivery is due to any of the exceptions noted in Paragraph 4.

(b) Terms of payment shall be as stated on invoice.

4. It is understood that deliveries will be made in accordance with Seller's regular production schedule. Every reasonable effort will be made to meet the Buyer's required delivery dates but Seller will not be liable for damages or be deemed to be in default by reason of any failure to deliver or delay in delivery due to any preference, priority, allocation or allotment order issued by the Government, whether Federal, State or local, or causes beyond its control including but not limited to, Acts of God or a public enemy, acts of Government, fires, floods, epidemics, quarantine restrictions, strikes, lockouts, freight embargoes, severe weather, unavailability of materials or shipping space, delays of carriers or suppliers or delays of any subcontractors. Should delay in delivery be caused by any of the circumstances mentioned in this paragraph, such extension of the delivery period shall be granted as is reasonable under the circumstances of the case. Should delay be caused by an event not specifically mentioned in this paragraph, damages will be limited to cancellation of the purchase order without penalty, and refund of any monies deposited or prepaid on the purchase order with no liability for any consequential or incidental damages.

5. Seller reserves the right to increase the prices prior to Seller's acceptance of order and/or after expiration of any price quoted by Seller.

6. Unless otherwise stated in writing, Seller's prices do not include sales, excise, value-added or other taxes. Consequently, in addition to the price specified herein, the amount of any present or future sales, use, excise, value-added or other tax applicable to the manufacture, sale, purchase or use of the products hereunder shall be paid by Buyer, or in lieu thereof, Buyer shall provide Seller with a valid tax exemption certificate acceptable to the taxing authorities.

7. Seller reserves the right, at any time, to revoke any credit extended to Buyer because of Buyer's failure to pay for any products when due or for any other reason deemed good and sufficient by Seller and in such event, all subsequent shipments shall be paid for prior to at delivery at Seller's option.

8. (a) SELLER'S LIABILITY SHALL BE LIMITED TO SELLER'S STATED SELLING PRICE PER UNIT OF ANY DEFECTIVE GOODS AND SHALL IN NO EVENT INCLUDE BUYER'S MANUFACTURING COSTS, LOST PROFITS, GOODWILL, OR ANY OTHER SPECIAL, INDIRECT, INCIDENTAL OR CONSEQUENTIAL DAMAGES, ARISING OUT OF THE AGREEMENT, THIS CONTRACT, THE SALE OF THE PRODUCTS TO THE BUYER OR THE USE OR THE PERFORMANCE OF THE PRODUCTS. Seller may at its discretion repair, replace or give the Buyer credit (pro-rated) for such defective products.

(b) Notwithstanding anything herein to the contrary, Seller shall have no liability for alleged defects with the products which are not specified in written notice from the Buyer to the Seller within thirty-six (36) months from the date of shipment of machines. Seller shall pass to Buyer any warranty received by Seller from the manufacturer of Limited Life Components, which in most cases is 12 to 18 months.

(c) Seller shall have no liability under this Limited Warranty unless Buyer has paid in full for the products. Further, this Limited Warranty is expressly contingent on Buyer's delivery to Seller, all costs prepaid, the defective part(s) within thirty-six (36) months of shipment to Buyer, together with a written statement specifying the alleged defect(s). Any replacement part(s) shall be shipped to Buyer on a C.O.D. basis.

(d) SELLER SPECIFICALLY EXCLUDES ALL WARRANTIES, EXPRESSED, IMPLIED OR OTHERWISE, EXCEPT AS STATED EXPLICITLY IN THESE TERMS AND CONDITIONS OF SALE. SELLER DISCLAIMS THE WARRANTY OF MERCHANTABILITY AND FITNESS FOR A PARTICULAR PURPOSE.

9. The remedies herein reserved by Seller shall be cumulative and in addition to any other legal remedies. No waiver of a breach of any portion of this contract shall constitute a waiver of continuing or future breach of such provision or of any other provisions hereof.

10. These Terms and Conditions constitute the entire agreement of the parties. No amendments, changes, revisions or discharges hereof in whole or in part shall have any force or effect unless set forth in writing and signed by the parties hereto. This contract shall not be assignable by Buyer voluntarily by operation of law or otherwise without Seller's written consent.

11. This contract shall be governed and shall be construed according to the domestic laws of the Commonwealth of Pennsylvania.

12. Anything herein to the contrary notwithstanding, any action for alleged breach by Seller of the contract between the parties, including but not limited to any action for breach of the warranties herein set forth, shall be barred unless commenced by Buyer within one (1) year from the date such cause of action accrued.

13. This agreement shall inure to the benefit of and be binding upon the parties hereto, their respective successors and permitted assigns.

14. **All notices required by this contract to be given by either party shall be sent in writing or by facsimile and shall be addressed to the last known address of such other party. Notices shall be deemed to have been received on the fifth business day following deposit in the mail.**

Emulsion information for the screen printer

A technical information article by Douglas Grigar

Screen printers have available six types of photoreactive stencil materials. There are three direct emulsion choices, diazo, diazo/photopolymer (dual cure), and SBQ-photopolymer. There are also three photo reactive film choices, indirect film, direct/indirect film, and photoreactive capillary films.

Diazo emulsions are the least expensive and the first of the three emulsion types available on the market. Diazo emulsions are mid range in available exposure latitude and can have good edge definition. Drawbacks are that many require hardeners for long runs or water resistance lower solids content is often needed for reasonable viscosity.

Diazo Photopolymer emulsions are hybrids of the diazo and photopolymers and are also called dual cure. Dual cure emulsions are the newest available emulsions. Due to the hybrid nature they have the largest available feature and quality range. Dual cure emulsions will have the largest exposure latitude and are available in various levels of water and solvent resistant features. Dual cure emulsions generally have the best resolution, definition, and bridging qualities. Dual cure emulsions are midrange in price, and higher solids content versions are available with reasonable viscosity.

SBQ- Photopolymer emulsions are very fast in their exposure speeds but also have the smallest exposure latitude. They are pre mixed and have the longest shelf life. Pure photopolymer emulsions are the most expensive and are best matched with high quality single point exposure systems. Pure photopolymer emulsions have good resolution, definition, and bridging qualities. Pure photopolymer emulsions have the highest solids content available with reasonable and often excellent viscosity.

The solids content in an emulsion does

example would be that pure photopolymer emulsions are available in very high solids content with low viscosity. Emulsion viscosity can also change with temperature. Lower temperatures cause the emulsions to thicken. Solids content less than 30% with low viscosity are often difficult to coat without a mess. In addition, lower solids percentage will require multiple coatings to achieve reasonable mesh coverage.



Fig. 1

Emulsion Over Mesh or EOM is a measurement of the emulsion thickness on the face or substrate side of the mesh. EOM is a percentage of the mesh thickness. (Fig. 1) Too low of an EOM ratio will prevent a good gasket seal, prevent good detail resolution, and increase chances of saw tooth edges. Manufacturers recommend an EOM ratio of 10 to 20 percent.

With an emulsion stencil, more is not better. Too much emulsion on the face of the screen can cause difficult ink transfer and details can break down in a run. Emulsion drip from the mesh while drying is a definite indication that the coated emulsion is too thick.

Your emulsion manufacturer can recommend a coating procedure for each mesh count using a rounded or sharp coating edge.



Fig. 2

The step coating procedure (Fig. 2) is used to coat a screen to find your best coating technique for that mesh count. The step coating procedure starts with a stroke on the face of the mesh. Then

coat the squeegee side once over the entire screen. Coat again the squeegee side on only two thirds of the screen, then coat again one third of the squeegee side (all wet on wet).

Dry your screen as normal. When dry, face coat with the sharp edge of the squeegee two thirds of the screen from a crossing direction (perpendicular) then dry face up. When the screen is dry apply the last coat of emulsion on the face side covering only one third of the same direction as the last face coat, then dry. With the face coatings there will be nine examples of coating thicknesses. Pick an exposure time that fits the median coating technique and expose the screen with a test positive that covers all of the coating changes.

Wash out and dry as normal. Now you can view the emulsion with a loop or microscope. Inspect the changes in thickness, then print with this screen and inspect the printed results. With the printed results compared to the visual inspection, the best coating technique for that mesh count can be determined. Standardized mesh thread thickness and weave for each mesh count is needed for consistent and reliable results.

The step coating procedure can be used while eliminating some of the steps, or replace the face coatings with all wet on wet coating strokes.

All manufacturers recommend drying coated screens with the face down (squeegee side up) in a horizontal position. A slightly elevated temperature (not over 110 deg. F.), in a filtered drying room or cabinet, will dry screens in record time, often less than half an hour. A dehumidifier will drop emulsion drying time further.



Fig 3

Once the screen is dry, direct emulsion will dry and conform to the profile of the mesh fabric causing small hills and dips in the surface. The smoothness of the dry emulsion can be measured and is represented by the term Rz value. (Fig. 3) The lower the Rz measurement number the smoother the surface.

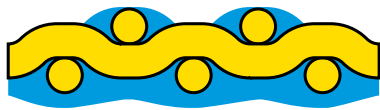

Fig. 4

Surface smoothness can affect your substrate to stencil gasket. The lower Rz numbers will be produced only by machine coating or film products. Direct/indirect and capillary films will produce the lowest Rz numbers possible for screen stencils. High solids content emulsions and face coating (second or more coats of emulsion over dry first coatings) can also lower your Rz measurements. (Fig. 4) Exact EOM and Rz numbers can only be measured by special testing equipment.

Indirect film products are presensitized emulsions on film. They are produced to expose and develop before they are attached to the screen mesh. Indirect film has fallen out of general use as products that are easier to use and have superior reproduction properties are now available.



Fig. 5

Capillary films are a photosensitive emulsion layered onto a film backing. (Fig. 5) The name is indicative of the action that causes the adhesion, capillary action. With wet screen fabric the film will draw into the mesh when placed in contact with the face of the screen.

Capillary films suffer from past bad reputation for delamination (Fig. 6) the current products available are capable of long runs and excellent detail. Capillary films produce the lowest Rz numbers possible and can save large amounts of screen room production time.

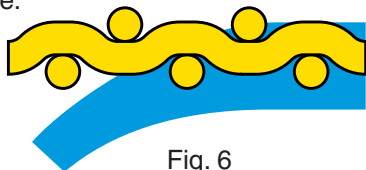

Fig. 6

Capillary films are best applied with the

(emulsion up) on a hard flat surface. (Fig. 7)

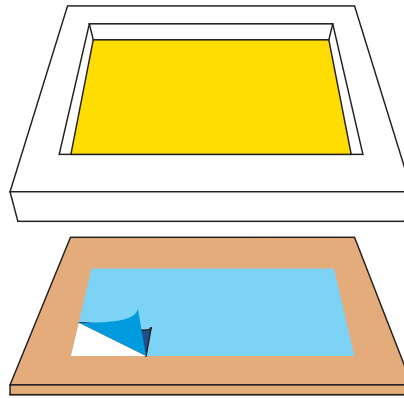

Fig. 7

Place a screen (squeegee side up) onto the film, lightly mist the mesh with a spray gun until the screen starts to draw up the capillary film into the fabric. (Fig. 8)

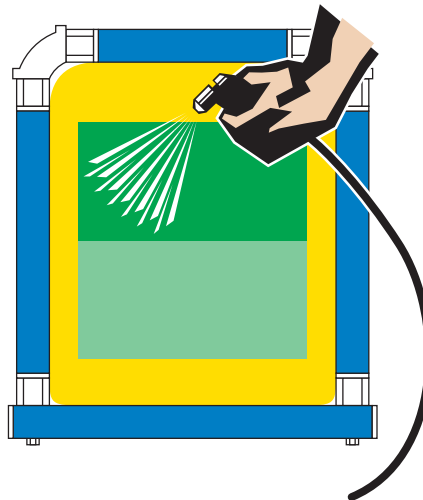

Fig. 8

Direct/indirect film products (combination stencils) are two-part film and emulsion combinations. Films assure low Rz numbers and high detail print quality. Direct emulsions produce high stencil durability. Direct/indirect film systems combine the best features of direct emulsion and film products, creating a strong, high definition stencil that will make longer runs possible with direct emulsion.

Direct/indirect film products require a coating of direct emulsion. Then the film can be adhered to the face (substrate side) of the screen. One method is to coat the screen (one stroke on each side of the screen) then place the screen (squeegee side up) on the film (emulsion side up) and stroke the squeegee side of the screen with a low

pressure stroke with a soft squeegee. (Fig. 9) The use of newsprint on your work surface will help with clean up.

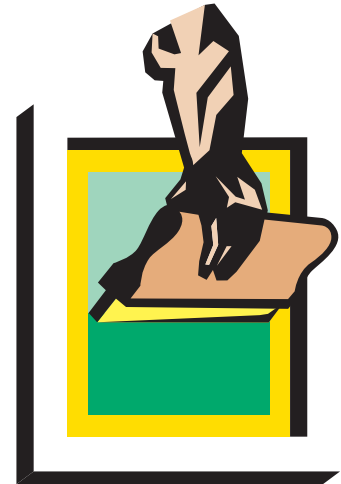
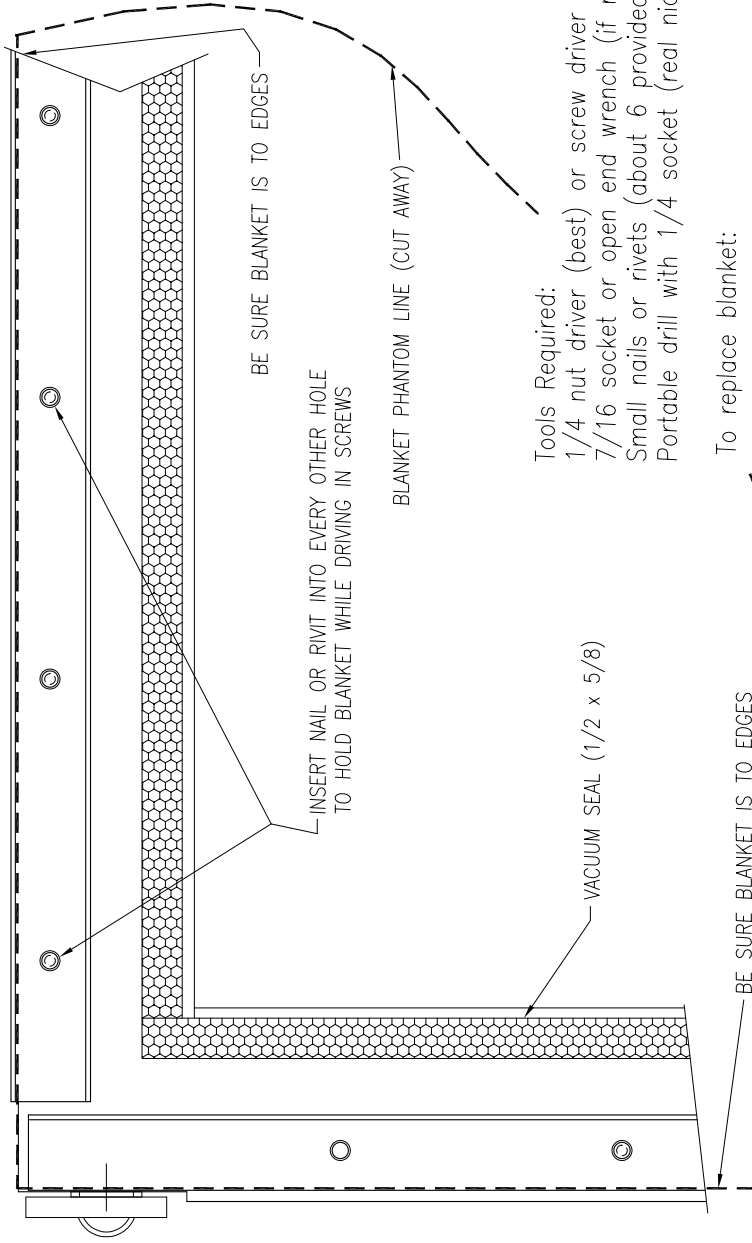

Fig. 9

Stay consistent and you will be able to predict your results with greater accuracy. Your goal should be consistency, predictability, and repeatability.

Graphics and text copyright 2002
Douglas Grigar dgrigar@hotmail.com



Tools Required:

- 1/4 nut driver (best) or screw driver (adequate)
- 7/16 socket or open end wrench (if removing lid)
- Small nails or rivets (about 6 provided)
- Portable drill with 1/4 socket (real nice but not a must)

To replace blanket:

- 1) Lift upper lid and turn completely over on its back.
 You will need to support the lid to hold it horizontally.
- 1A) If you do not have the room to turn the lid over you will have to remove it.
 To remove the lid: First release the gas springs then remove the (8) 1/4" screws located in the rear two corners.
- 2) Now remove the strip lock down screws all around the perimeter of the blanket.
- 3) Remove the four "Blanket lock strips" noting how it goes together and set aside.
- 4) Remove the old blanket.
- 5) *IMPORTANT* Place a spacer in the middle of the lid so the new blanket will not sag.
- 6) Place the new blanket into the lid, spreading it out to reach all sides.
 IMPORTANT Be sure the blanket reaches all the way to the edges as shown to the left.
- 7) Place the "Blanket lock strips" back onto the edges over the blanket.
- 8) Now you want "PIN" the blanket in 3 or 4 places along one edge. Using small nails or rivets (provided) push these pins through the strip lock down plates in every other hole, through the blanket and into the lid.
 This will secure the blanket while driving the screws back into the blanket. You can drive screws right through the blanket without making holes first. Work on one edge at a time.
- 9) After finishing one edge proceed to the opposite side and repeat.
 AGAIN be sure the blanket is reaching all the way to the edge.
- 10) After all sides are secure recheck all screws to be sure they ARE TIGHT!!

